



# I<sup>P</sup>AQ-L / I<sup>P</sup>AQ-LX

## Universal Intelligent 2-wire DIN Rail Transmitters

I<sup>P</sup>AQ-L is a universal and intelligent 2-wire DIN rail transmitter for temperature and other measurement applications.

I<sup>P</sup>AQ-LX is the Intrinsic Safe version for use in Ex-applications.

The combination of *competitive pricing, functionality and simple configuration* has made I<sup>P</sup>AQ-L and I<sup>P</sup>AQ-LX leading DIN rail transmitters for industrial temperature measurements.

The Windows based and user friendly software, I<sup>P</sup>RO 4, is used for transmitter configuration, documentation, monitoring and calibration purposes.

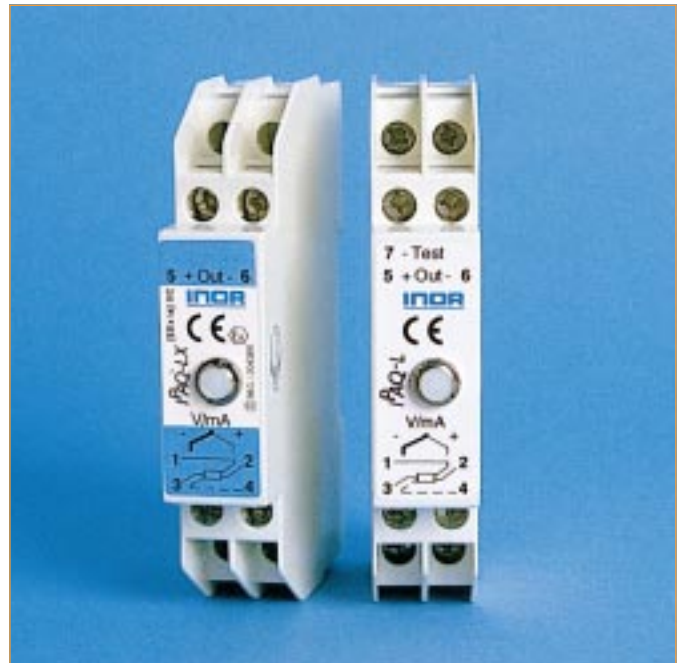

### Performance and design:

#### Excellent stability

- Long-term stability 0.1 %/year.

#### Enhanced total system accuracy

- Sensor error correction (for known sensor errors).
- System error correction (against known temperatures).

#### NAMUR-compliant

- Output limitations and fail currents according to NAMUR recommendations

#### Input-Output isolation 1500 VAC

- Eliminates measuring errors due to ground loops.

#### High load capacity

- Only 7.5 V voltage drop over the transmitter (I<sup>P</sup>AQ-L) allows for high loads.

#### Designed for harsh conditions

- Excellent EMC performance.
- Durable due to protected PCBs.

#### Space saving and simple mounting

- Only 17.5 mm / 0.7 inch wide.
- Quick mounting on DIN rail.

5 year limited warranty.

### Functions:

#### Input for RTDs, T/Cs, mV and resistance

- Reduced inventory costs.
- Simplified plant engineering.

#### Input for mA (separate version of I<sup>P</sup>AQ-L)

- Active 2-wire isolator / load amplifier.
- Only 10  $\Omega$  input impedance.

#### True on-line communication

- Full access to all features while in operation.

#### Sensor diagnostics

- Selectable sensor break action.

#### Simplified loop check-up

- The transmitter works as an accurate current generator.

#### On-screen indications and line recording

- Valuable tools for temporary measurements.

## Main features of IPAQ-L and IPAQ-LX

### Accuracy and stability

IPAQ-L/IPAQ-LX are designed for applications with standard industrial demands on accuracy. To reach these demands, the following factors are essential:

**Linearity and calibration errors** -The use of quality components and precision calibration equipment reduce these errors, e.g.  $\pm 0.1\%$  of span for RTD inputs.

**High long-term stability** -Internal "self calibration", by means of continuous adjustment of important parameters after comparison with accurate built-in references, contributes to a stability of  $\pm 0.1\%$  /year.

### Measurements with RTDs and other resistances

IPAQ-L/IPAQ-LX accept inputs from standardized Platinum and Nickel RTDs like Pt10...Pt1000 acc. to IEC 751 ( $\alpha=0.00385$ ), Pt100 acc. to JIS 1604 ( $\alpha=0.003916$ ) and Ni100/Ni1000 acc. to DIN 43760, as well as inputs from plain resistance sensors such as potentiometers. 3- or 4-wire connection can be chosen.

### Measurements with thermocouples, voltage and current

IPAQ-L/IPAQ-LX accept inputs from 11 types of standardized thermocouples as well as plain mV input. A separate version of IPAQ-L is available for current input.

For T/C input, the CJC (cold junction compensation) is fully automatic, by means of an accurate measurement of the terminal temperature. Alternatively, the CJC can be disabled.

### Customized linearization and Engineering units

The *Customized linearization* can be used to create a linearization curve for RTD, T/C, resistance, mV and mA inputs. By combining *Customized linearization* with the use of *Engineering units*, the transmitters can be programmed to give a linear output corresponding to a specific measuring range expressed in the primary process value. The sensor characteristics are described by a maximum of 9 data pairs. Fig. 1a and 1b.

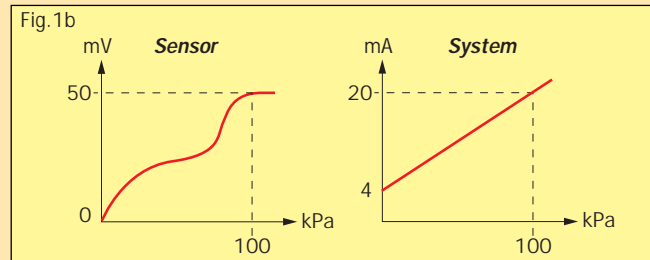
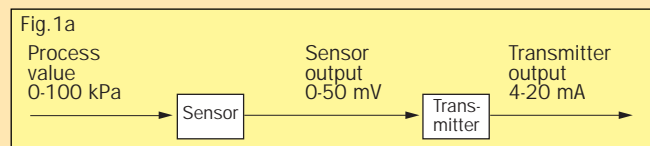

Example of a system (sensor + transmitter) with an output **linear** to the process value, in spite of a **non-linear** sensor.

### Sensor or System error correction

IPAQ-L/IPAQ-LX offer two ways of improving the measurement with temperature sensors:

**Sensor error correction** - Known sensor errors compared to the standard curve, e.g. for a calibrated sensor, are entered, and the transmitter automatically corrects for the sensor errors. Fig. 2.

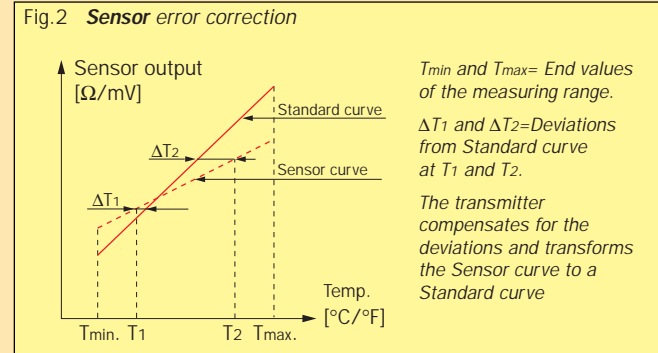

**System error correction** -This method is used to correct the system error (sensor + transmitter error) by exposing the sensor to one (one-point correction) or two (two-point correction) accurately measured temperatures (true temperatures). The true temperature(s) are entered, and the transmitter automatically corrects for the system errors. Fig. 3.

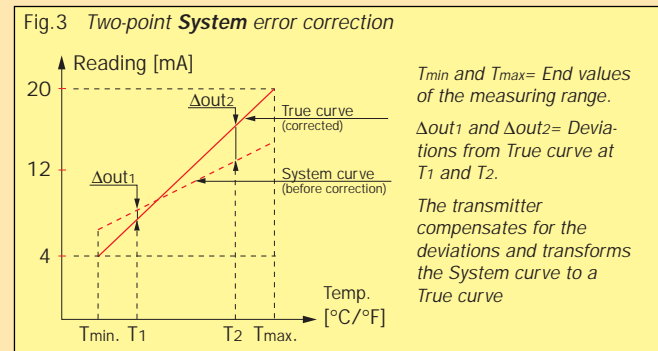

### Sensor break monitoring

IPAQ-L/IPAQ-LX monitor sensor break and force the output signal to a user defined level, when *any* sensor lead is broken or disconnected. The sensor break monitoring can be switched off. The monitoring is furnished with a *pulsed excitation current*. This eliminates the voltage drop in the lead wires (giving a measuring error), caused by a standard DC excitation current.

### Controlled output for instrument calibration

IPAQ-L/IPAQ-LX can be set to automatically provide a recurring output current regardless of the input signal. The total time for the controlled output is adjustable up to 30 minutes.

**Dampening**

The dampening function can be used to dampen undesired instabilities on the input signal. The dampening time is approximately 2 seconds. The dampening time is the time required, in addition to the update time, for the output to reach 90% of its final value after a step change has been applied to the input.

**Power supply**

IPAQ-L/IPAQ-LX are loop-powered and will work on voltages down to 7.5 VDC (8.0 VDC for IPAQ-LX), thus giving good margins for high loads in the current loop. Reversed polarity will not damage the transmitter. Fig. 4

**Mounting**

IPAQ-L/IPAQ-LX are designed to fit on a standard 35 mm rail according to DIN EN 50022.

**Warranty**

IPAQ-L/IPAQ-LX are covered by a 5 year limited warranty.

**IPRO 4 - The user friendly software for all transmitters of the IPAQ family**

IPRO 4, which is used with all IPAQ-transmitters, is the tool to utilize all the versatile functions of the IPAQ-L/IPAQ-LX such as:

- Measurement configuration: Sensor type, range, sensor or system error correction, linearization, engineering units, output settings, filter activation, etc.
- Monitoring of sensor status: Sensor break detection.
- On-screen real time presentation of measured values and output signal in the form of numericals, meters, bar graphs and line recorder.
- Transmitter calibration: Field calibration in one or two points and basic calibration.
- Documentation: Configuration files can be saved for future use and configuration protocols can easily be printed.

The communication with the transmitter can be performed on line, i.e. with transmitter in operation. An isolated and Ex-approved communication cable is included in the software kit, IPRO-X.

IPRO 4 is compatible with Windows 3.1, Windows 3.11, Windows 95 and Windows NT Workstation 4.0. The program is menu-driven and easy to learn. On-line help is an effective tool for the user.

**IPAQ-L/IPAQ-LX Configuration scheme**

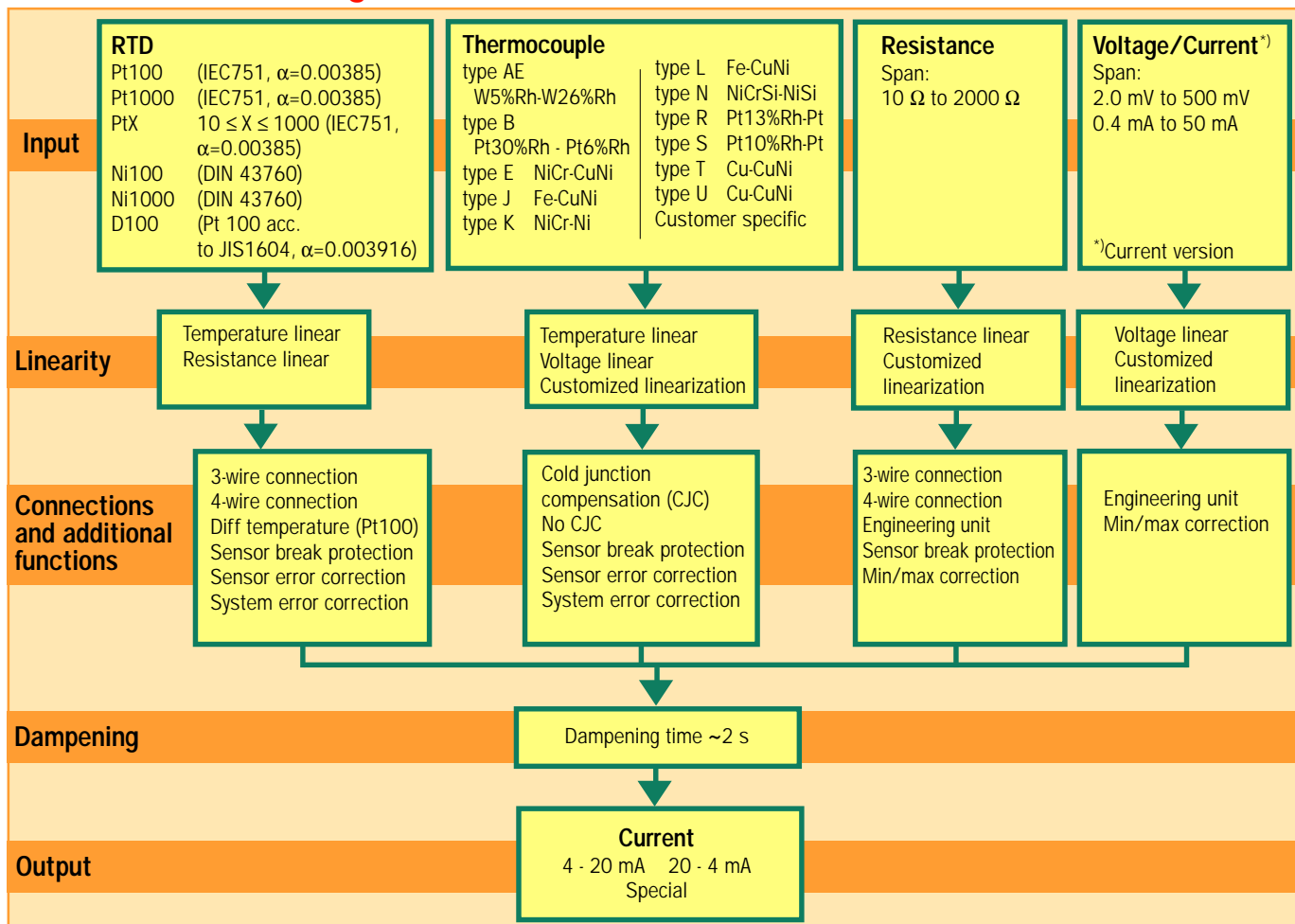

## Specifications

<b>Input</b>		
<b>RTD's and Resistance</b>		
Pt100 (IEC751, $\alpha = 0.00385$ )	3-, 4-wire connection	-200 to +1000 °C / -328 to +1832 °F
Pt1000 (IEC751, $\alpha = 0.00385$ )	3-, 4-wire connection	-200 to +200 °C / -328 to +392 °F
PtX $10 \leq X \leq 1000$ (IEC751, $\alpha = 0.00385$ )	3-, 4-wire connection	Upper range depending on X-value
Ni100 (DIN 43760)	3-, 4-wire connection	-60 to +250 °C / -76 to +482 °F
Ni1000 (DIN 43760)	3-, 4-wire connection	-60 to +150 °C / -76 to +302 °F
D100 (Pt 100 acc.to JIS1604, $\alpha = 0.003916$ )	3-, 4-wire connection	-200 to +1000 °C / -328 to +1832 °F
Potentiometer/resistance	3-, 4-wire connection	0 to 2000 $\Omega$
Sensor current		~ 0.4 mA
Maximum sensor wire resistance		25 $\Omega$ /wire
<b>Thermocouples, Voltage and Current</b>		
T/C	Type: AE, B, E, J, K, L, N, R, S, T, U	Ranges according to users manual
Voltage		-10 to +500 mV
Current	IPAQ-L <sup>1)</sup>	-1 to +50 mA
Input impedance	T/C, Voltage	>10 M $\Omega$
	Current	10 $\Omega$
Maximum sensor wire resistance	T/C, Voltage	500 $\Omega$ (total loop)
<b>Monitoring</b>		
Sensor break monitoring	User definable output	3.5 to 21.6 mA
<b>Adjustments</b>		
Zero adjustment	All inputs	Any value within range limits
Minimum spans	Pt100, Pt1000, Ni100, Ni1000	10 °C / 18 °F
	Potentiometer	10 $\Omega$
	T/C, Voltage	2 mV
	Current	0.4 mA
<b>Output</b>		
Straight, reversed or any intermediate value		4-20/20-4 mA
Resolution		5 $\mu$ A
Minimum output signal	Measurement/Failure	3.8 mA / 3.5 mA
Maximum output signal	Measurement/Failure	20.5 mA / 21.6 mA
Permissible load, see fig.4	IPAQ-L	750 $\Omega$ @ 24 VDC, 22 mA
	IPAQ-LX	725 $\Omega$ @ 24 VDC, 22 mA
<b>Temperature</b>		
Ambient, storage		-20 to +70 °C / -4 to +158 °F
Ambient, operation		-20 to +70 °C / -4 to +158 °F
<b>General data</b>		
Selectable dampening time		~ 2 s
Update time		~ 1.5 s
Isolation In - Out	Isolated versions	1500 VAC, 1 min
Humidity (non-condensing)		0 to 95 % RH
Intrinsic safety	IPAQ-LX, ATEX	II (1) G [EEx ia] IIC
	FM	I.S.Connections to Class I-III, Div. 1, Group A-G
<b>Power supply, polarity protected</b>		
Supply voltage	IPAQ-L	7.5 to 36 VDC 2-wire
	IPAQ-LX	8.0 to 30 VDC 2-wire
Permissible ripple		4 V p-p @ 50/60 Hz

<sup>1)</sup> Separate version of IPAQ-L, only for current input.

Accuracy		
Linearity	RTD Potentiometer, mV, mA	$\pm 0.1\%$ <sup>1)</sup>
	T/C	$\pm 0.2\%$ <sup>1)</sup>
Calibration	RTD	Max. of $\pm 0.2\text{ }^\circ\text{C}$ / $\pm 0.4\text{ }^\circ\text{F}$ or $\pm 0.1\%$ <sup>1)</sup>
	Potentiometer	Max. of $\pm 0.1\ \Omega$ or $\pm 0.1\%$ <sup>1)</sup>
	mV, T/C	Max. of $\pm 20\ \mu\text{V}$ or $\pm 0.1\%$ <sup>1)</sup>
	mA (IPAQ-L) <sup>4)</sup>	Max. of $\pm 4\ \mu\text{A}$ or $\pm 0.1\%$ <sup>1)</sup>
Cold Junction Compensation (CJC)	T/C	$\pm 0.5\text{ }^\circ\text{C}/\pm 0.9\text{ }^\circ\text{F}$
Temperature influence <sup>5)</sup>	All inputs	Max. of $\pm 0.25\text{ }^\circ\text{C}/25\text{ }^\circ\text{C}$ or $\pm 0.25\%/25\text{ }^\circ\text{C}$ <sup>1)3)</sup>
		Max. of $\pm 0.5\text{ }^\circ\text{F}/50\text{ }^\circ\text{F}$ or $\pm 0.28\%/50\text{ }^\circ\text{F}$ <sup>1)3)</sup>
Temperature influence CJC <sup>5)</sup>	T/C	$\pm 0.5\text{ }^\circ\text{C}/25\text{ }^\circ\text{C}$ / $\pm 1.0\text{ }^\circ\text{F}/50\text{ }^\circ\text{F}$
Instrument calibration output	4-20 mA	$\pm 8\ \mu\text{A}$
Sensor wire resistance influence	RTD, Potentiometer, 3-wire	Negligible <sup>2)</sup>
	RTD, Potentiometer, 4-wire	Negligible
	mV, T/C, mA	Negligible
Load influence		Negligible
Power supply influence		Negligible
RFI influence, 0.15-1000 MHz, 10 V or V/m		$\pm 0.2\%$ <sup>1)</sup> (typical)
Long-term stability		$\pm 0.1\%$ <sup>1)</sup> /year
Housing		
Material / Flammability (UL)		PC + Glass fibre/VO
Mounting		Rail acc. to DIN EN 50022, 35 mm
Connection	Single/stranded wires	$\leq 1.5\text{ mm}^2$ , AWG 16
Weight		70 g
Protection, housing / terminals		IP 20 / IP20

<sup>1)</sup> Of input span

<sup>2)</sup> With equal wire resistance

<sup>3)</sup> If zero-deflection > 100% of input span:  
add 0.125% of input span/ $25\text{ }^\circ\text{C}$  or 0.14%  
of input span/ $50\text{ }^\circ\text{F}$  per 100% zero-deflection

<sup>4)</sup> Separate version of IPAQ-L, only for current input

<sup>5)</sup> Reference temperature  $23\text{ }^\circ\text{C}/73\text{ }^\circ\text{F}$

**The User Instructions must be read prior to adjustment and/or installation.**

## Intrinsic Safety specifications

Specifications	IPAQ-LX, isolated	IPAQ-LX, isolated
Approval	Demko / ATEX	Factory Mutual (FM)
Classification	II (1) G [Ex ia] IIC	IS connections to Class I-III, Div. 1, Group A-G
Certificate No.	DEMKO 03 ATEX 134461X	J.I. 0D6A8.AX, Drw. 3-7852
Output/Supply		
Max voltage to transmitter	$U_i = 30\text{ Vdc}$	$V_{max} = 30\text{ Vdc}$
Max current to transmitter	$I_i = 100\text{ mA}$	$I_{max} = 100\text{ mA}$
Max power to transmitter	$P_i = 0.9\text{ W}$	$P_{max} = 900\text{ mW}$
Internal inductance	$L_i = 0\text{ mH}$	Not applicable
Internal capacitance	$C_i = 1\text{ nF}$	Not applicable
Input (Sensor)		
Max voltage from transmitter	$U_o = 30\text{ Vdc}$	$V_{oc} = 30\text{ Vdc}$
Max current from transmitter	$I_o = 27\text{ mA}$	$I_{sc} = 25\text{ mA}$
Max power from transmitter	Not specified	Not specified
Max inductance (input loop)	$L_o = 50\text{ mH}$	$L_a = 56.8\text{ mH}$
Max capacitance (input loop)	$C_o = 52\text{ nF}$	$C_a = 0.12\ \mu\text{F}$

INPUTS

RTD

Pt100, Pt1000, Ni100, Ni1000, PtX, D100  
4-wire connection

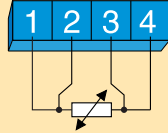

3-wire connection

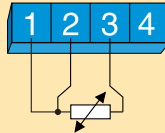

Pt100  
Diff temperature  $T_1 > T_2$

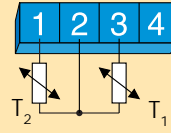

Potentiometer

4-wire connection

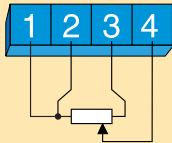

3-wire connection

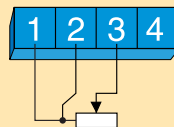

Voltage/Current \*)

mV/mA \*)

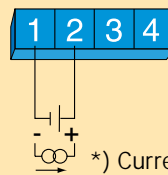

\*) Current version

Thermocouple

AE, B, E, J, K, L, N, R, S, T, U  
or customer specific

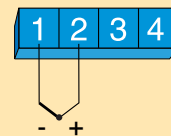

OUTPUT

4-20 mA Output

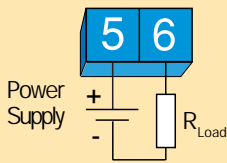

Connections

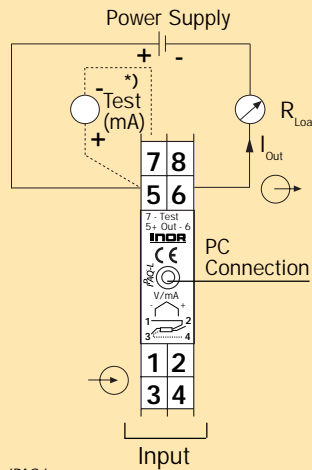

\*) Only IPAQ-L

Dimensions

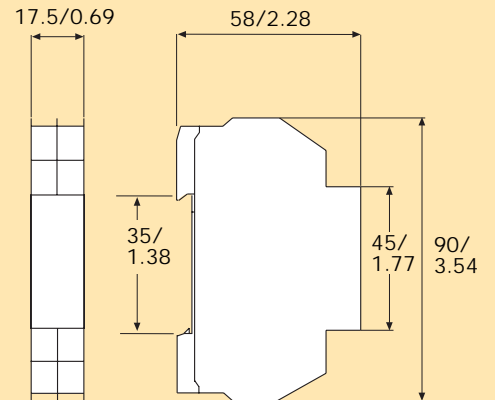

mm / inches

Output load diagram

Fig.4

Permissible  $R_{Load}$  at 22 mA output

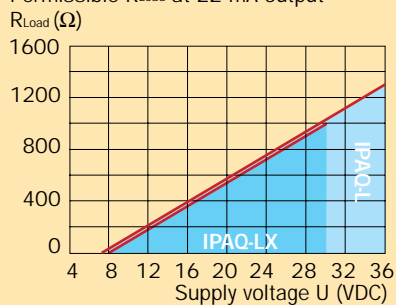

$R_{Load} = (U - 7.5) / 0.022$  (IPAQ-L)  
 $R_{Load} = (U - 8.0) / 0.022$  (IPAQ-LX)

Ordering table

Item	Part No.
<b>Transmitter</b>	
IPAQ-L, isolated	70IPL00001
<del>IPAQ-L, non-isolated</del>	<del>70IPL00002</del>
IPAQ-L, current, isolated	70IPL00003
<del>IPAQ-L, current, non-isolated</del>	<del>70IPL00004</del>
IPAQ-LX, isolated (ATEX)	70IPLX0001
IPAQ-LX, isolated (FM)	70IPLX1001
<b>Options</b>	
Configuration	70CAL00001
Configuration with 5-point calibration certificate	70CAL00051
<b>Software and cable</b>	
PC Configuration kit	70CFG00092
<del>Software IPRO upgrade</del>	<del>70IPRS00001</del>