

Sanitary Pressure Transmitter Type S-10-3A

Datasheet S-10-3A

Applications

- Food and beverage
- Pharmaceutical
- Cosmetic

Special Features

- Compliant with 3A
- Available with 3/4", 1.5" or 2.0" Tri-Clamp® connections
- 4-20 mA 2-wire output signal, others available
- Available with an integral cooling extension for high temperature applications
- Stainless steel case and wetted components



S-10-3A



S-10-3A.C

≥1½" Tri-Clamp®
process connection



WIKA S-10-3A pressure transmitters are in compliance with 3A 3rd party sanitary criteria for pressure and level measurement in the food, pharmaceutical, cosmetic and beverage

industries. They feature 0.5% accuracy, 0.25 % B.F.S.L, rugged stainless steel construction, and a wide operating temperature range.

The 316L SS flush diaphragm minimizes product buildup. The all welded diaphragm seal system includes FDA and USP approved system fill fluid and is designed for "clean in place" (CIP) and "sterilize in place" (SIP) maintenance procedures. The transmitters are available with industry standard 3/4", 1.5" or 2.0" Tri-Clamp® connections. The S-10-3A.C is designed for use with media temperatures up to 350°F (177°C).

Each transmitter undergoes extensive quality control testing and calibration. The printed circuit boards use state-of-the-art surface mount technology and are potted in silicone gel for protection against mechanical shock, vibration and moisture. Each transmitter is manufactured to assure accuracy and long term stability when exposed to severe ambient temperature variations.

STANDARD RANGES ⁽¹⁾

RANGE	1.5" Tri-Clamp® Part #	2.0" Tri-Clamp® Part #
30"-0 HgVac	9766329	9744770
30"-0-30 psi	8997395	4204042
30"-0-60 psi	9799732	4224167
30"-0-100 psi	4204387	4300840
0-15 psi	9748202	9748210
0-30 psi	9748075	4225007
0-50 psi	4215789	4215771
0-60 psi	9744703	9748199
0-100 psi	9748237	9747931
0-160 psi	9748245	9748253
0-200 psi	9749408	4213246
0-250 psi	9776227	4268831
0-300 psi	8990985	4253877
0-500 psi	4205081	9745828
0-1,000 psi	8993470	4281737

⁽¹⁾ Standard part numbers listed above include a S-10-3A, 4-20 mA two wire output signal and a DIN 43650 electrical connector.

Tri-Clamp® is a registered trademark of Tri-Clover Inc.

Specifications	Units	Type S-10-3A / S-10-3A-C
Sensing principle		piezoresistive up to 300 psi, thin film > 400 psi
Pressure ranges	psi	standard ranges as listed {custom ranges available}
Pressure reference		relative pressure {absolute pressure reference available}
Pressure connection		
Process connection		1.5" or 2.0" Tri-Clamp® connection {Electropolished available} {others available}
Diaphragm surface finish	Ra	< 20 µin
Material:		
Wetted parts		1.4435 (316L SS) {others available}
■ Case		1.4301 (304 SS)
■ Internal transmitting liquid		KN 92 Mineral oil - FDA and USP approved {others available}
Supply voltage U_B	DC Volts	10 - 30 (14 - 30 for 0 - 10 V output signal)
Output and load limitations:		
Output signal and maximum load		4-20 mA 2-wire system RA[Ohm] < (UB [V] -10V) / 0.02 A {0-20 mA 3-wire system} RA[Ohm] < (UB [V] -10V) / 0.02 A {0-5 V 3-wire system} RA> 5 kOhm (min) {0-10 V 3-wire system} RA> 10 kOhm (min) {other signal outputs available}
Response time (10...90%)	ms	< 10
Zero and span adjustment	% of span	Approximately ±5%
Accuracy ¹⁾ (non-linearity, including hysteresis and non-repeatability)	% of span	<0.5% (0.25 % B.F.S.L.) (Calibrated in vertical mounting position with process connection down)
Repeatability	% of span	< 0.05
1 year stability	% of span	< 0.2 (under reference conditions)
Temperature		
■ Media:		
S-10-3A		-22° F to +248° F (-30° C to +120° C)
S-10-3A.C		-22° F to +350° F (-30° C to +177° C)
■ Ambient		-4° F to +176° F (-20° C to +80° C)
■ Storage		-40° F to +212° F (-40° C to +100° C)
Temperature error: (reference 70° F) ²⁾		
■ On zero point	% of span	< 0.5 per 18° F (10° C) change
■ On span	% of span	< 0.5per 18° F (10° C) change
CE conformity		
		97/23/EC 2004/108/EEC, EN 61 326 Emission Group (Group 1, Class B) and Immunity)industrial locations
Electrical connection		4 pin L-plug per DIN 43 650 with solderless screw terminal & PG 13 fitting {4 pin L-plug with 1/2" female conduit opening, 5 foot vented flying lead, 4 or 6 pin MIL plug}
Weight	lb	approximately 1.2 (0.6 Kg)
Dimensions		see drawing
Electrical protection		protected against reverse polarity, short circuit, and overvoltage
Environmental protection		IP 65 (NEMA 5) with 4 pin L-plug, {MIL plugs} {IP 67 (NEMA 4) with 5 foot flying lead

Notes: 1) Accuracy valid for 1.5" and 2.0" Tri-Clamp®
2) Temperature error valid for 1.5" and 2.0" Tri-Clamp®
Items in curved brackets { } are available as special order options

Dimensions

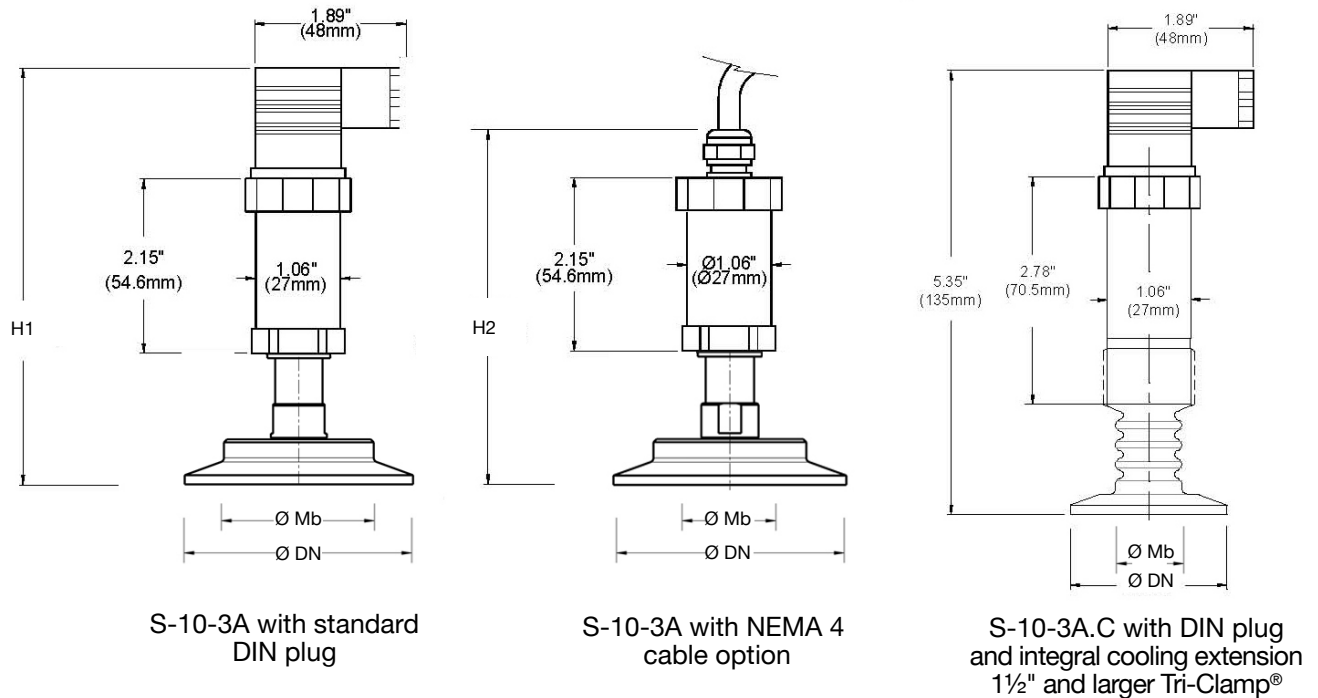

PROCESS CONNECTION	DN	Mb	H1	H2
3/4" Tri-Clamp® *	0.98"	0.6"	5.1"	4.5"
1.5" Tri-Clamp®	1.97"	1.0"	5.0"	4.4"
2.0" Tri-Clamp®	2.52"	1.6"	5.0"	4.4"

Note: * Accuracy: 1.0% (0.5% B.F.S.L.)
 Temperature error on zero point: 1.0 per 18°F (10°C) change
 Temperature error on span: 1.0 per 18°F (10°C) change

Electrical connections

L-connector, DIN EN 175301-803, Form A (DIN 43 650) for conductor cross section up to max. 1.5 mm², conductor outer diameter 0.3" (6-8 mm), NEMA 5 / IP 65
 Order code: A4

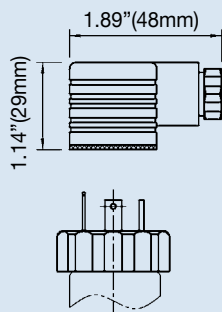

Circular connector M 12x1, 5-pin, NEMA 4 / IP 67
 Order code: M5

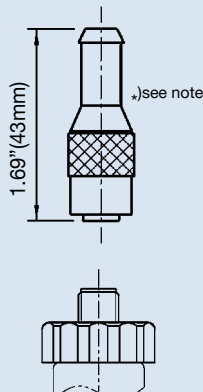

Flying leads conductor cross section up to max. 0.5 mm² / AWG 20 with end splices, conductor outer diameter 6.8 mm, NEMA 4 / IP 67
 Order code: DL

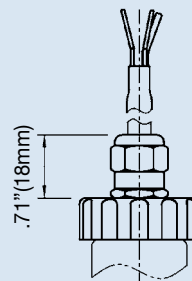

Cable with free ends, adjustable zero and span conductor cross section up to max. 0.5 mm² / AWG 20 with end splices, conductor outer diameter 6.8 mm, NEMA 6 P / IP 68
 Order code: XM

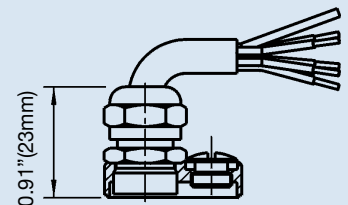

Wiring

2-wire system

L-Connector,
DIN EN 175301-803, Form A
(DIN 43 650)

M12x1 Circular connector
5 pin

Vented cable with free ends

Legend:



power supply	Sig+ output signal positive
	UB+ power supply positive
load (e.g. display)	0V power supply negative
	Sig- output signal negative

3-wire system

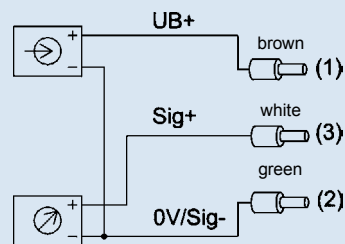
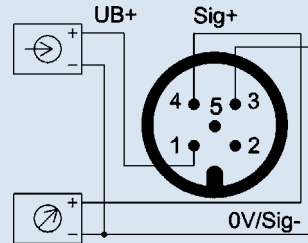
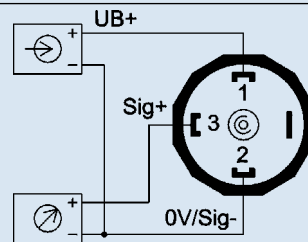
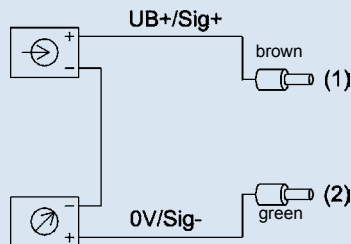
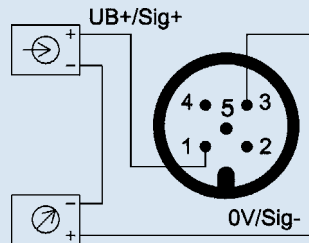
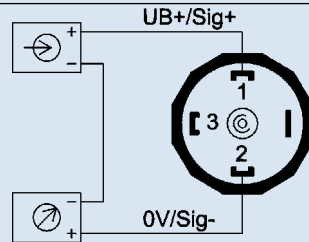

Specifications and dimensions given in this data sheet represent the state of engineering at the time of printing. Modifications may take place and materials specified may be replaced by others without prior notice.

Specifications and dimensions given in this data sheet represent the state of engineering at the time of printing. Modifications may take place and materials specified may be replaced by others without prior notice.